



FIELDMANN[®]
Home & Garden Performance

20V Li-ION
FASTPOWER



FZN 70225-0

English	3-18
Čeština.....	19-32
Slovenčina	33-46
Magyarul	47-60
Polski	61-74

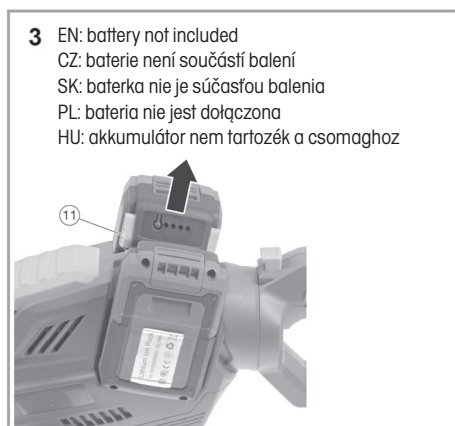
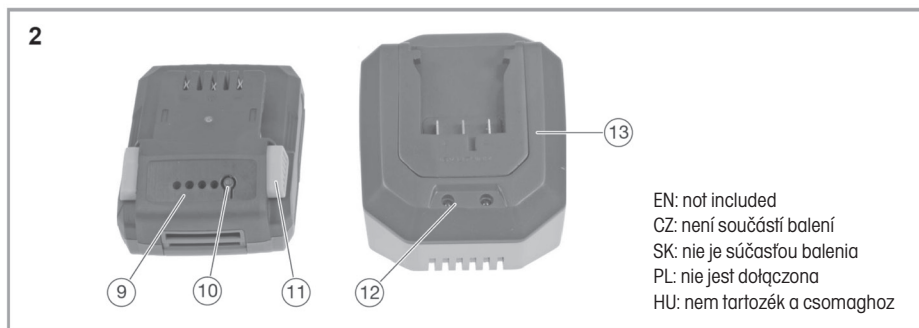
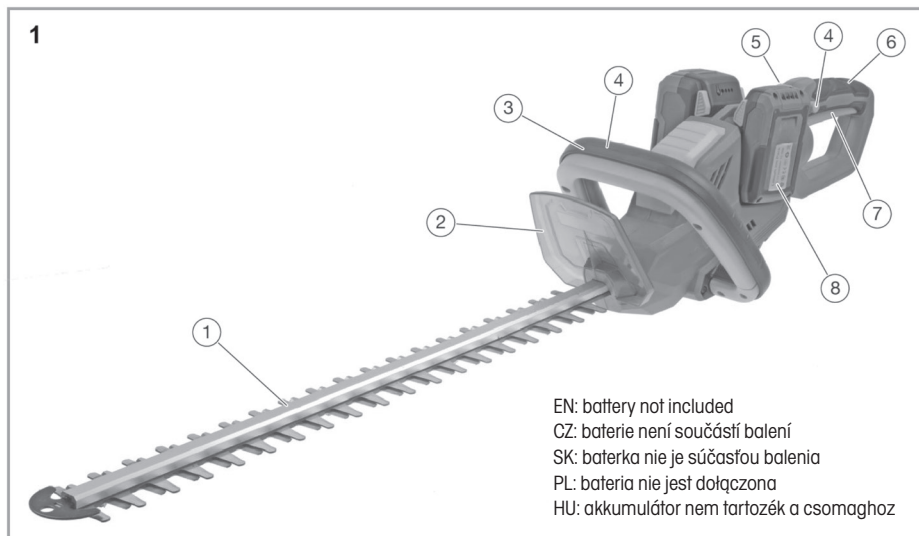

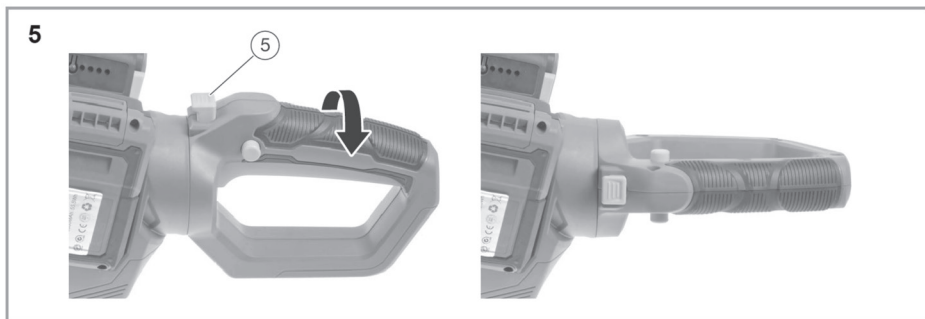

Cordless hedge trimmer

USER'S MANUAL

Thank you for purchasing this cordless hedge trimmer. Before you start using them, please, carefully read this user's manual and save it for possible future use.

TABLE OF CONTENTS



1. IMPORTANT SAFETY INSTRUCTIONS.....	6
2. SYMBOLS.....	7
3. MACHINE DESCRIPTION AND PACKAGE CONTENT	8
4. CORDLESS HEDGE TRIMMER APPLICATION	9
5. SAFETY INSTRUCTIONS.....	9
6. SCOPE OF APPLICATION	12
7. OPERATION	12
8. TECHNICAL DATA	14
9. CLEANING AND MAINTENANCE	14
10. STORING AND TRANSPORT.....	15
11. TROUBLE SHOOTING.....	15
12. DISPOSAL.....	16
13. DECLARATION OF CONFORMITY	17

1. IMPORTANT SAFETY INSTRUCTIONS

WARNING!

Carefully read the instruction manual before use.

IMPORTANT SAFETY WARNINGS

-  Unpack the product carefully and be sure not to throw away any part of the package before having found all components of the product.
-  Keep the product in a dry place out of reach of children.
-  Read all cautions and instructions. The failure to adhere to warning cautions and instructions may result in an accident, fire and/or a serious injury.

PACKAGING

The product is placed in a package preventing damage during transport. This package is a raw material therefore it can be handed-over for recycling.

INSTRUCTIONS FOR USE

Before beginning to work with the machine, read the following safety rules and instructions for use. Familiarize with operating elements and the proper use of the device. Keep the manual in a safe place for future reference. We recommend keeping the original package including the inner packaging materials, cash voucher and guarantee card for a period of warranty at minimum. For a case of transportation, pack the machine into the original box from the manufacturer, thus ensuring a maximum protection of the product during a possible transport (e.g. moving or sending into a service station).

 **Note:** If you hand the machine over to next persons, hand it over together with the manual. Adherence to the attached instructions for use is a precondition for the proper use of the machine. The operation manual includes also instructions for operation, maintenance and repairs.

The manufacturer does not take any responsibility for accidents or damages resulting from the failure to adhere to this manual.

2. SYMBOLS



Risk of injury when instructions are not followed.



Protect the tool from the damp and never expose it to rain!



Read the Instruction Manual attentively prior to use.



Use eyes protective equipment.



Use ears protective equipment.



Guaranteed sound power level Lwa
90dB (A).

3. MACHINE DESCRIPTION AND PACKAGE CONTENT

Note:

The actual appearance of the product may differ from that shown in the illustrations.

Figure 1

1. Cutting system
2. Hand protector
3. Front handle
4. Lock-off button
5. Lock button for handle adjustment
6. Rear handle
7. Power switch
8. Battery (not included in the delivery)

Figure 2

9. Remaining capacity indicator
10. Charge status button
11. Interlock button
12. Indicator lights
13. Battery charging dock (not included in the delivery)

INCLUDED IN THE DELIVERY

- ✿ User Guide
- ✿ Battery-powered hedge trimmer
- ✿ Battery and charger not included !
- ✿ Blade protector

4. CORDLESS HEDGE TRIMMER APPLICATION

APPROPRIATE APPLICATION

The cordless hedge trimmer is intended for cutting hedges, shrubs and low-lying plants in private domestic gardens and allotments. Appropriate application of the cordless hedge trimmer is conditioned by keeping of the instructions mentioned in the Instruction Manual.

WARNING!

Risk of injury! Do not use the cordless hedge trimmer to mow grass/lawn edges, or to cut the organic material for composting.



5. SAFETY INSTRUCTIONS

Attention!

ATTENTION! For safety reasons, the cordless hedge trimmer may not be operated by persons under 16 years of age and by persons not familiarized with information contained in this manual. Persons with reduced mental or physical abilities may operate the cordless hedge trimmer only if they are under supervision of a responsible person or have been trained by a qualified responsible person.

Attention!

In case of improper use, this power tool may be dangerous. Follow warning and safety instructions specified in the instruction manual; only this way you will ensure adequate safety and efficiency when working with this tool. The compliance with the warning and safety instructions specified in this instruction manual and on the tool is the responsibility of the tool operator. Never use the tool unless the protective guards mounted by the tool manufacturer are in the correct position.

-  Wear the appropriate eye protection.
-  General warnings on the tool safety.

BASIC SAFETY INSTRUCTIONS WHEN WORKING WITH POWER TOOLS

Attention!

WARNING! Familiarize yourself with all the warning and safety instructions and with the tool operating instructions. Failure to adhere to warning or safety instructions may result in electric shock, fire and/or serious injury.

Attention!

Keep all the warning and safety instructions in a practical place for future reference.

The term "power tool" in all warning instructions specified hereafter means both mains-operated (corded) and battery-operated (cordless) power tool.

WORK AREA SAFETY

- ☼ Keep work area clean and well lit. Cluttered or dark areas at the workplace invite accidents. Do not operate power tools in explosive atmospheres, such as in the presence of flammable liquids, gases or dust. Power tools create sparks which may ignite the dust or fumes.
- ☼ Keep children and bystanders away while operating a power tool. Distractions can cause you to lose control over the activity performed.

ELECTRICAL SAFETY

- ☼ Power tool plugs must match the mains outlet. Never modify the plug in any way. Do not use any adapter plugs with earthed (grounded) power tools. Unmodified plugs and matching outlets will reduce the risk of electric shock.
- ☼ Avoid body contact with earthed or grounded surfaces, such as pipes, radiators, ranges and refrigerators. There is an increased risk of electric shock if your body is earthed or grounded. Do not expose power tools to rain or wet conditions. Water entering a power tool will increase the risk of electric shock.
- ☼ Do not abuse the cord. Never use the cord for carrying, pulling or unplugging the power tool. Keep cord away from heat, oil, sharp edges or moving parts. Damaged or entangled cords increase the risk of electric shock.
- ☼ When operating a power tool outdoors, use an extension cord suitable for outdoor use. Use of a cord suitable for outdoor use reduces the risk of electric shock.
- ☼ If operating a power tool in a damp location is unavoidable, use a residual current device (RCD) protected supply. Use of residual current device (RCD) reduces the risk of electric shock.

PERSONAL SAFETY

- ☼ Stay alert, watch what you are doing and use common sense when operating a power tool. Do not use a power tool while you are tired or under the influence of drugs, alcohol or medication. A moment of inattention while operating power tools may result in serious personal injury.
- ☼ Use personal means of protection. Always wear eye protection. Safety equipment such as dust mask, non-skid safety shoes, hard hat, or hearing protection used in conformity with the working conditions will reduce personal injuries.
- ☼ Avoid accidental starting. Ensure the switch is in the off-position before connecting the battery, storing or carrying the power tool. Carrying power tools with your finger on the switch or plugging in power tools that have the switch on invites accidents.
- ☼ Remove any adjusting tools or wrenches before turning the power tool on. An adjusting tool or wrench left attached to a rotating part of the power tool may result in personal injury.
- ☼ Do not overreach. Keep proper footing and balance at all times. This enables better control of the power tool in unexpected situations.
- ☼ Dress properly. Do not wear loose clothing or jewellery. Keep your hair, clothing and gloves away from moving parts. Loose clothes, jewellery or long hair can be caught in moving parts. If devices are provided for the connection of dust extraction and collection facilities, ensure these are connected and properly used. Use of these devices can reduce dust-related hazards.

POWER TOOL USE AND MAINTENANCE

- ✿ Do not force the power tool. Use the correct power tool for your application. The correct power tool will do the job better and safer at the rate for which it was designed.
- ✿ Do not use the power tool if the switch does not turn it on and off. Any power tool that cannot be controlled with the switch is dangerous and must be repaired.
- ✿ Unplug the power cord from the mains outlet and/or remove the battery from the power tool before making any adjustments, changing accessories, or storing power tools. Such preventative safety measures reduce the risk of starting the power tool accidentally.
- ✿ Store idle power tools out of the reach of children and do not allow persons unfamiliar with the power tool or these instructions to operate the power tool. Power tools are dangerous in the hands of untrained users.
- ✿ Maintain power tools. Check for misalignment or binding of moving parts, pay particular attention to cracks, breakage of parts and any other condition that may affect the power tool's operation. If damaged, have the power tool repaired before use. Many accidents are caused by poorly maintained power tools.
- ✿ Keep cutting tools sharp and clean. Properly maintained cutting tools with sharp cutting edges are less likely to bind and are easier to control.
- ✿ Use the power tool, accessories and tool bits etc., in accordance with these instructions and in the manner intended for the particular type of power tool, considering the given working conditions and the work to be performed. Use of the power tool for operations other than those for which the power tool is intended could result in hazardous situations.

SERVICE

- ✿ Have your power tool serviced by a qualified repair person using only original replacement parts. This will ensure that the safety of the power tool is maintained.

SAFETY INSTRUCTIONS WHEN WORKING WITH CORDLESS HEDGE TRIMMER

- ✿ Keep all parts of the body away from the cutter blade. Do not remove cut material or hold material to be cut when blades are moving. Make sure the main switch is off when clearing the material jammed in the cordless hedge trimmer. A moment of inattention while operating the cordless hedge trimmer may result in serious personal injury.
- ✿ Carry the cordless hedge trimmer by the handle with the cutter blade stopped. Always fit the blade scabbard while transporting or storing the cordless hedge trimmer. Proper handling of the telescopic cordless hedge trimmer will reduce possible personal injury from the cutter blades.
- ✿ Hold the power tool by insulated gripping surfaces only to avoid contact of the cutter blades of the cordless hedge trimmer with hidden electric wires or its own power cord. Cutter blade contacting "live" wire may expose metal parts of the power tool "live" and could give the operator an electric shock.
- ✿ Keep the power cord away from the cutting area. During operation the cable may be hidden in shrubs and may be accidentally cut by the blade.

6. SCOPE OF APPLICATION

Use the cordless hedge trimmer exclusively for trimming hedges, shrubs and other woody ornamentals. If the cordless hedge trimmer is used for purposes other than those specifically mentioned in the manual, there is a risk of damage to the trimmer or serious personal injury.

7. OPERATION

7.1 CHARGING THE BATTERY PACK

CAUTION!

Risk of injury! Comply with all safety Instructions when handling rechargeable devices.

NOTICE!

Risk of damage to the unit! Do not allow the battery pack to deep discharge.





NOTICE!

Risk of damage to the unit! Do not press the On/Off switch after the device has deactivated automatically.



 **Note:** The Li-Ion battery pack can be charged at any time without affecting the lifetime of the unit. Interrupting the charging process will not damage the battery pack.

 **Note:** If the battery is fully loaded, the charger automatically switches over to the maintenance charge function. The battery can thus remain in the charger permanently.

The battery pack must be charged prior to the first start-up. (charging time: around 60 minutes).

-  Press in the battery pack release button (12) and remove the battery from the device. (See Fig. A, B)
-  Insert the battery pack into the charger. (See Fig. C)
-  Plug the charger into the power supply. The charging status is displayed by the control lights (13). (More information Charger Indicator section.)
-  Slot the battery pack into the device and make sure it clicks into place correctly. (See Fig. D, E)

Checking the remaining capacity of the battery.

-  Press the battery capacity indicator switch button (11).
-  The remaining capacity of the battery is displayed by the 4LED control lights (10). Battery capacity indicator as below:

All 4 LEDs are lit:

The battery is fully charged.

3 or 2 or 1 LED(s) are lit:

The battery has an adequate remaining charge.

1 LED blinks:

The battery is empty, recharge the battery.

All LEDs blink:

The battery pack is too hot or too cold.

7.2 CHECK BEFORE USE!**⚠ DANGER!**

Attention, danger of injury! Do not operate the appliance unless you did not find any faults. If a part has become defective, make sure to replace it before you use the appliance again.

Check the safety devices and the safe condition of the appliance:

- ✿ Check all parts for tightness.
- ✿ Check the appliance for visual damage: broken parts, cracks, etc.

7.3 CUTTING HEDGES**⚠ NOTICE!**

Risk of damage to the appliance! Take particular care close to fences! If trimmings, fence wire or similar is caught in the cutting equipment, switch the appliance off immediately.

- ✿ Remove blade guard. (See Fig. F)
- ✿ Switching on: Press the switch lock (4) and simultaneously press the On/Off switch (6). Do not push the point into the hedge. (See Fig. G)
- ✿ Switching off: Release the On/Off switch (6).
- ✿ After switching off wait until the blade is stationary.
- ✿ Mount blade guard.

7.4 TIPS ON HEDGE TRIMMING**⚠ NOTICE!**

Risk of environmental damage! Do not use the cordless hedge trimmer during normal periods of quiet and rest. Before cutting a hedge, check that there are no birds nesting.

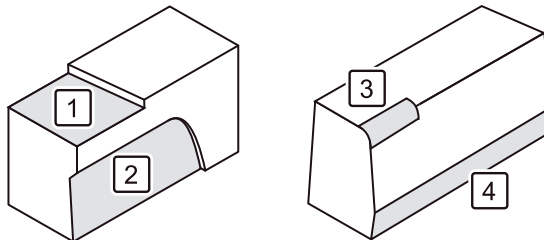

1. Cut the hedge to the desired height.
2. Trim the side of the hedge diagonally from bottom to top.
3. Round off the upper corners of the hedge.
4. Cut back the hedge somewhat at ground level.

8. TECHNICAL DATA

Item number	FZN 70225-0
Rated voltage	2x 20 V
Stroke rate	2400 RPM
Cutting diameter	16 mm
Operational time	25 min (2Ah), 50 min (4Ah), 90 min (8Ah)
Electronic brake	yes
Bar length	610 mm



ACCESSORIES

Item number	Accessory
FDUZ 79020	Battery pack 2 Ah
FDUZ 79040	Battery pack 4 Ah
FDUZ 79100	Fast charger
FDUZ 79110	Fast dual charger
FDUZ 79080	Battery pack 8 Ah
FDUZ 79200	Fast Super Charger

9. CLEANING AND MAINTENANCE

DANGER!

Risk of Injury! Before any maintenance or cleaning work:



-  Remove the battery.
-  Let the device cool down.

Overview of cleaning

If necessary

What?	How?
Clean the machine	► Cleaning the machine section: Oil cutting tool and clean with brush. Then, spray oil on all sides of the cutting tool.

Cleaning the machine



-  Remove any coarse dirt.
-  Wipe the appliance with a slightly damp cloth.

10. STORING AND TRANSPORT



STORING

DANGER!

Danger of injury! Make sure no unauthorised persons can gain access to the appliance!

-  Slip the protection cover over the cutting equipment.
-  Store the appliance where it is dry and well ventilated.

TRANSPORT

-  Slip the protection cover over the cutting equipment.
-  Secure the appliance against slipping.
-  If shipping, use the original packaging wherever possible.

11. TROUBLE SHOOTING

WHEN SOMETHING ISN'T WORKING

DANGER!

Risk of injury! Improperly performed repairs can lead to the device not functioning safely. This endangers yourself and your environment.

Malfunctions are often caused by minor faults. You can easily remedy most of these yourself. Please consult the following table before contacting the vendor. You will save yourself a lot of trouble and possibly money too.

Fault/malfunction	Cause	Remedial measure
Device does not work.	Battery not slotted in correctly?	Slot battery into place.
	Battery pack discharged?	▶ Charging the battery.
	Battery pack defective?	Contact your online service.
	Is the device defective?	

If you can't fix the fault yourself, contact your online service. Please be aware that any improper repairs will also invalidate the warranty and additional costs may be incurred.

12. DISPOSAL



The machine, rechargeable batteries, accessories and packaging should be sorted for environmentalfriendly recycling.

Do not dispose of power tools and batteries/rechargeable batteries into household waste!

Only for EC countries:



According to the European Guideline 2012/19/EU, power tools that are no longer usable, and according to the European Guideline 2006/66/EC, defective or used battery packs/batteries, must be collected separately and disposed of in an environmentally correct manner.

INSTRUCTIONS AND INFORMATION ON DISPOSING OF USED PACKAGING MATERIALS

Put any used package material to the place determined by the municipality for waste disposal.

DISPOSAL OF USED ELECTRIC AND ELECTRONIC EQUIPMENT



This symbol on products or accompanying documents means that used electric or electronic products must not be put to ordinary municipal waste. Hand over such products to determined collection points for proper disposal, restoration and recycling. Alternatively, in some countries of the European Union or other European countries you can return your products to your local dealer when you buy an equivalent new product. By dutiful disposal of this product you can preserve precious natural resources and you help prevent any potential adverse effects on the environment and human health which could be the results of wrong waste disposal. Ask your local authority or the nearest collection point for additional details. In case of improper disposal of this waste kind penalties can be imposed in accordance with national regulations.

For companies in the European Union countries

Should you want to dispose of electric and electronic devices, ask your dealer or vendor for necessary information. Disposal in other countries outside the European Union. Should you want to dispose of this product, ask your local authorities or your dealer for necessary information about disposal method.



This product fulfils all basic requirements of the EU directives that apply to it.

Text, design and technical specifications can change without prior notice and we reserve the right for their change.

User manual in the original language.

13. DECLARATION OF CONFORMITY



FAST ČR, a.s.
 U Sanitasu 1621, 251 01 Říčany, Czech Republic
 tel.: +420 323 204 111, fax: +420 323 204 110

EU DECLARATION OF CONFORMITY

Product / brand: Cordless Hedge Trimmer / **FIELDMANN**

Type / model: **FZN 70225-0** as factory model D05002701
 DC 40V max (battery powered)
 $L_{PA} = 86,2 \text{ dB(A)}$, $L_{WA} = 95 \text{ dB(A)}$

Manufacturer: FAST ČR, a.s.
 U Sanitasu 1621, 251 01 Říčany, Czech Republic
 VAT no: CZ2477749

This declaration of conformity is issued under the sole responsibility of the manufacturer.

The object of the declaration described above is in conformity with the relevant Union harmonization legislation:

Directive MD 2006/42/EC
 Directive EMC 2014/30/EU
 Directive NEE 2000/14/EC
 Directive RoHS 2011/65/EU+(EU)2015/863

The relevant harmonized standards and the other technical specifications:

EN 62841-1:2015+AC+A11
 EN 62841-4-2:2019+A1+A11
 EN IEC 55014-1:2021
 EN IEC 55014-2:2021



Place of issuance: Prague
Date of issuance: 05. 09. 2024

Name: Ing. Luboš Cinek - Responsible Person
Signature:



FAST ČR, a.s.
 U Sanitasu 1621, 251 01 Říčany
 tel.: +420 323 204 111
 IČO: 247 77 749, DIČ: CZ 247 77 749

IČO: 24777749, DIČ: CZ24777749

Bankovní spojení: Komerční banka Praha 1, č.ú. 89309011/0100, ČSOB Praha 1, č.ú. 8010-0116233383/0300
 Česká spořitelna Praha 4, č.ú. 2375682/0800